



MODEL:

Delabie DLB-1466040

DELABIE

FEATURES & BENEFITS

- Automatic hot water shut off in case of cold water supply failure.
- Minimum flow rate required to operated: 5 lpm.
- Integrated non-return valves.
- Thermal shocks can be undertaken without special equipment.

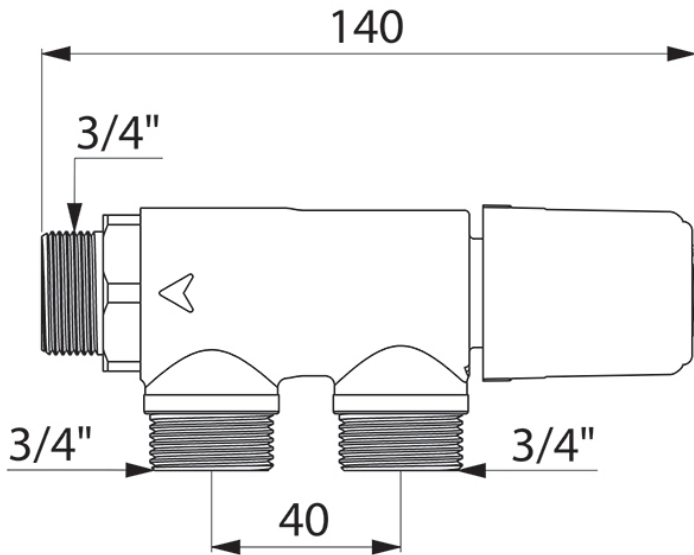

Dimensions are in millimeters. If a Cad file is required please visit www.mechline.com.



MECHLINE DEVELOPMENTS LIMITED

Tel: +44 (0)1908 261511 | Email: info@mechline.com | Web: www.mechline.com