



MODEL:

**AquaJet AJPR30-ST-BF2-A**

# AQUAJET

AquaJet Pre-Rinse Spray. AJPR30 base / STANDARD style / BF2 bowl filler / ANGLED gun

**Accreditation:** WRAS

**Tap Hole Centres:** 170-230mm adjustable

**Base:** AJPR30

**Bowl Filler:** 300mm bowl filler (BF2)

**Connection(s):** 2x (M) 1/2-inch

**Controls:** Lever

**Model Range:** AquaJet 30

**Mount:** Deck mounted

**Pedestal:** Twin

**Spray Gun:** Angled

**Style:** Standard

**Water Feed:** Twin

### FEATURES & BENEFITS

- A variety of choices to suit each application.
- WRAS approved across the range.
- Pre-assembled, ready to install - saves time on site.
- All assembled models are factory tested up to 6 bar for quality assurance.
- Choice of optional bowl fillers, water dispensing guns and accessories.
- Restraining device available to prevent hose from overstretching into basin, which reduces abuse and helps meet Water Board regulations.
- Super strong, food-grade, high-flow water hose.

### TECHNICAL INFO

- Connections: 2x (M) 1/2-inch
- Tap hole req: 2x 25mm
- Flow rates: 7.99 lpm tested at 3 bar pressure.

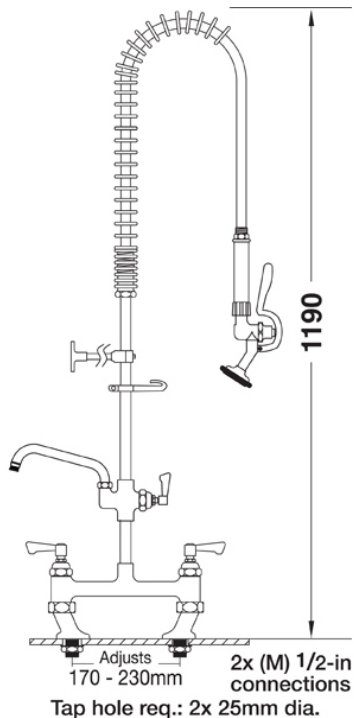

Dimensions are in millimeters. If a Cad file is required please visit [www.mechline.com](http://www.mechline.com).



MECHLINE DEVELOPMENTS LIMITED

Tel: +44 (0)1908 261511 | Email: [info@mechline.com](mailto:info@mechline.com) | Web: [www.mechline.com](http://www.mechline.com)