



MODEL:

AquaJet AJPR30-HM-BF2-W

AQUAJET



AquaJet Pre-Rinse Spray. AJPR30 base / HANGMAN style / BF2 bowl filler / WATER SAVING gun

Accreditation: WRAS

Tap Hole Centres: 170-230mm adjustable

Base: AJPR30

Bowl Filler: 300mm bowl filler (BF2)

Connection(s): 2x (M) 1/2-inch

Controls: Lever

Model Range: AquaJet 30

Mount: Deck mounted

Pedestal: Twin

Spray Gun: Water Saving

Style: Hangman

Water Feed: Twin

FEATURES & BENEFITS

- A variety of choices to suit each application.
- WRAS approved across the range.
- Pre-assembled, ready to install - saves time on site.
- All assembled models are factory tested up to 6 bar for quality assurance.
- Choice of optional bowl fillers, water dispensing guns and accessories.
- Restraining device available to prevent hose from overstretching into basin, which reduces abuse and helps meet Water Board regulations.
- Super strong, food-grade, high-flow water hose.

TECHNICAL INFO

- Connections: 2x (M) 1/2-inch
- Tap hole req: 2x 25mm
- Flow rates: 4.44 lpm tested at 3 bar pressure.

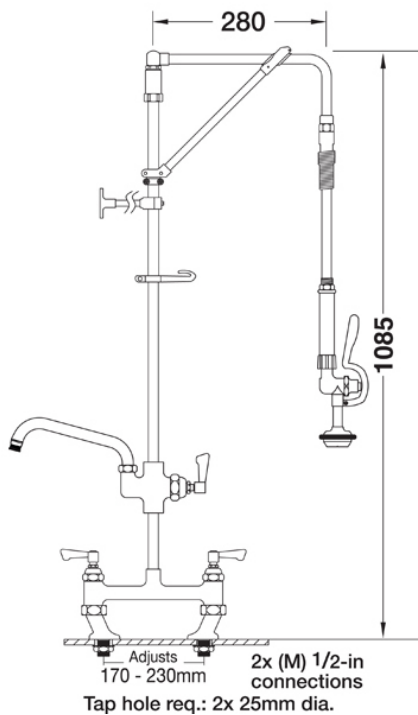

Dimensions are in millimeters. If a Cad file is required please visit www.mechline.com.



MECHLINE DEVELOPMENTS LIMITED

Tel: +44 (0)1908 261511 | Email: info@mechline.com | Web: www.mechline.com