



MODEL:

AquaJet AJPR20-SH-BF1-E

AQUAJET



AquaJet Pre-Rinse Spray. AJPR20 base / SHORT style/ BF1 bowl filler / EcO gun

- Accreditation:** WRAS
- Base:** AJPR20
- Bowl Filler:** 150mm bowl filler (BF1)
- Connection(s):** 2x (M) 1/2-inch
- Controls:** Lever
- Model Range:** AquaJet 20
- Mount:** Deck mounted
- Pedestal:** Single
- Spray Gun:** EcO
- Style:** Short
- Water Feed:** Twin Monobloc

FEATURES & BENEFITS

- A variety of choices to suit each application.
- WRAS approved across the range.
- Pre-assembled, ready to install - saves time on site.
- All assembled models are factory tested up to 6 bar for quality assurance.
- Choice of optional bowl fillers, water dispensing guns and accessories.
- Restraining device available to prevent hose from overstretching into basin, which reduces abuse and helps meet Water Board regulations.
- Super strong, food-grade, high-flow water hose.

TECHNICAL INFO

- Connections: 2x (M) 1/2-inch
- Tap hole req: 30mm
- Flow rates: 2.97 lpm tested at 3 bar pressure.

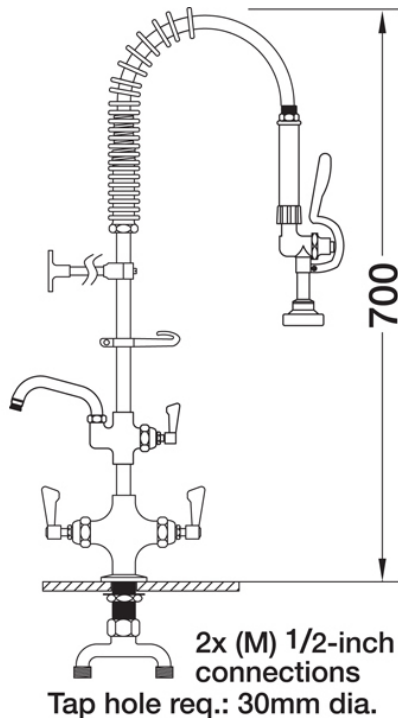

Dimensions are in millimeters. If a Cad file is required please visit www.mechline.com.



MECHLINE DEVELOPMENTS LIMITED

Tel: +44 (0)1908 261511 | Email: info@mechline.com | Web: www.mechline.com