



MODEL:

AquaJet AJPR15-ST-BF3-S

AQUAJET

AquaJet Pre-Rinse Spray. AJPR15 base / STANDARD style / BF3 bowl filler / STANDARD gun

- Accreditation:** WRAS
- Base:** AJPR15
- Bowl Filler:** 400mm bowl filler (BF3)
- Connection(s):** (F) 1/2-inch
- Controls:** Lever
- Model Range:** AquaJet 15
- Mount:** Panel mounted
- Pedestal:** Single
- Spray Gun:** Standard
- Style:** Standard
- Water Feed:** Single Monobloc

FEATURES & BENEFITS

- A variety of choices to suit each application.
- WRAS approved across the range.
- Pre-assembled, ready to install - saves time on site.
- All assembled models are factory tested up to 6 bar for quality assurance.
- Choice of optional bowl fillers, water dispensing guns and accessories.
- Restraining device available to prevent hose from overstretching into basin, which reduces abuse and helps meet Water Board regulations.
- Super strong, food-grade, high-flow water hose.

TECHNICAL INFO

- Connection: (F) 1/2-inch
- Tap hole req: 25mm
- Flow rates: 7.79 lpm tested at 3 bar pressure.

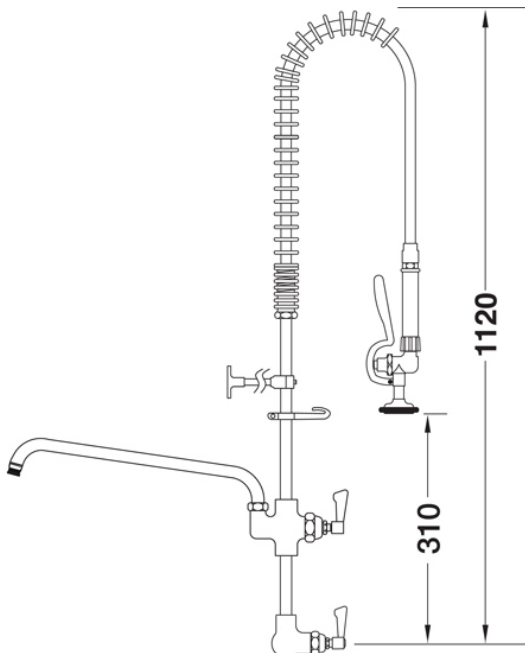

(F) 1/2-inch connection
Tap hole req.: 25mm dia.

Dimensions are in millimeters. If a Cad file is required please visit www.mechline.com.



MECHLINE DEVELOPMENTS LIMITED

Tel: +44 (0)1908 261511 | Email: info@mechline.com | Web: www.mechline.com